

# PVE52



Rated Load  
238 kg



Panoramic view  
360°



Unique Design



Vacuum  
Technology



Installation  
within 2-3 days



Plug&Play  
Single phase 220v



Customizable  
finishes



Minimal  
maintenance



Eco-friendly



No pit  
required



Maximum  
Safety



### General

External cylinder diameter (mm)	1316
Rated load (kg)	238
Speed	<0.15m/s
Number of stops	2 to 5
Maximum Total travel (m)	15

### Doors

Available Door openings	0° and 180°
Default hinges position (from outside the cabin)	Right
Optional hinges position (from outside the cabin)	Left
Automatic door option	Yes
Door height (mm)	2024
Height upto top of the door closer (mm)	2078

### Cabin

Internal cabin height (mm)	2010
Interior cabin diameter (mm)	
without columns	1210
between columns	1096
Entrance width opening (mm)	813
Electrical circuits with all controls in cabin	24V
Automatic Push (one-touch press)	Yes
Foldable cabin seat	No
Wheelchair accessible	Yes

### Security









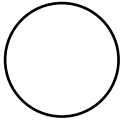

Automatic descent in the event of power failure	Yes
Mechanical emergency brakes	Yes
Overload limiting system	Yes
Alarm button	Yes
Telephone	Yes
Electromechanical interlocks at each landing	Yes

### Installation requirements

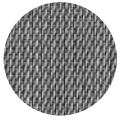
Through floor perforation required diameter (mm)	1389
Minimum height in upper floor (mm)	2450
Level ground	Yes

### Electricity/Power

Power Supply	220V single-phase line of 3 (phase, neutral, earth) x 10mm (cross-section of each cable)
Maximum power	6kW
Required protection	32A Circuit Breaker

	Structure Colours	Cabin Floor	Ceiling Finishes
Standard Colours	 White	 Golden Brown	 Brushed
	 Bluish Grey	 Metallic	 Mirror
	 Light Grey	 Black	
	 Matte Black		
Special Colours	 Silver		
	 Taupe		

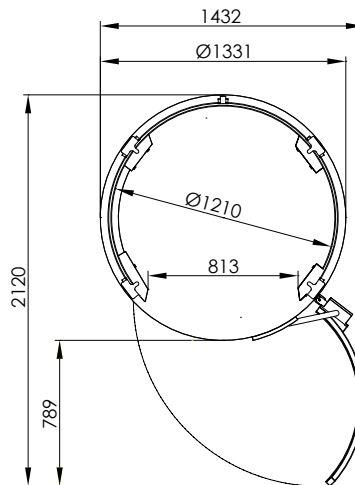

### DOOR OPENINGS

